



COMPAQ

Including:

- Model-Specific Features
- Upgrade Information

Mobile Internet PC Features Guide

1600 Series

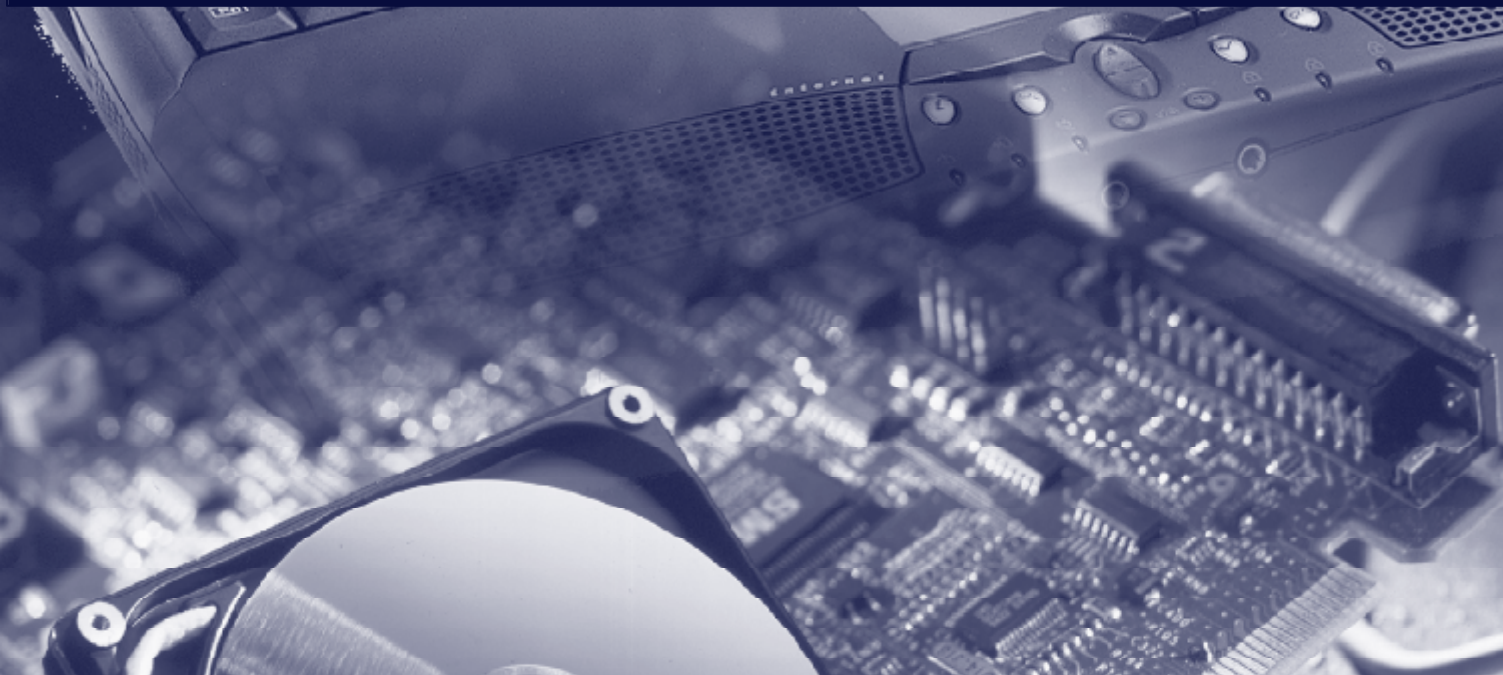

Contents

CHAPTER 1

Using This Guide

Text Conventions.....	1-1
Special Messages	1-2
Locating Help	1-2
Glossary	1-2
Index	1-2
Troubleshooting.....	1-2
Understanding Your Service and Support Options	1-3
Comments about this Guide	1-3

CHAPTER 2

Introducing Your Mobile Internet PC

Checking Your Connections.....	2-1
Front of Your Mobile Internet PC.....	2-2
Using Your Keyboard to Access the Internet.....	2-5
Internet Zone Buttons	2-5
Reprogramming Your Internet Zone Buttons	2-6
Disabling and Enabling the Internet Zone Buttons	2-6
Left Panel of Your Mobile Internet PC	2-7
Right Panel of Your Mobile Internet PC	2-8
Back Panel of Your Mobile Internet PC.....	2-9
Bottom of Your Mobile Internet PC.....	2-10
Inserting the Battery.....	2-11
Removing the Battery	2-12
Charging the Battery	2-12
Battery Charging Time	2-12

Spare or Extra Batteries 2-12
Plugging In Your Computer to AC Power..... 2-13
Unplugging the Computer from AC Power 2-13

CHAPTER 3

Mobile Internet PC Features

Turning On Your Mobile Internet PC 3-1
Turning Off Your Mobile Internet PC Properly 3-1
 Standard Off Mode 3-1
 Full Off (Main Power Off) Mode 3-2
Recovering from a Locked Program or System..... 3-2
 Recovering from a Locked Program..... 3-2
 Recovering from a Locked System 3-3
Using the Numeric Keypad..... 3-4
Using the Scroll Button 3-5
Understanding Your Computer Status Lights 3-5
Understanding Your Status Display 3-6
Using the Function Keys 3-7
 User-Programmable Keys..... 3-8
Adjusting the Volume 3-9
 Adjusting the Volume Using Windows 3-9
Using Display² 3-9
 Playing Audio CDs Using Display² 3-11
 Using Repeat Track..... 3-12
 Using Repeat All..... 3-12
Setting Up Your TV-Out Connection..... 3-13
 Connecting and Enabling TV-Out 3-13
 Setting Up Your Television Format..... 3-15
 Adjusting the Television Screen..... 3-15

Switching Between Displays3-16
Write-Protecting a Diskette3-16

CHAPTER 4

Learning About Your Modem

Performance Features4-1
Identifying Your Modem4-1
56K ITU V.90 Standard4-2

CHAPTER 5

Upgrading Your Mobile Internet PC

Adding More Memory5-1
 Installing Memory Expansion Modules5-2
What Are PC Cards?5-4
PC Card Types5-4
Inserting a PC Card5-5
Removing a PC Card5-6
Compaq-Compatible PC Cards5-7
Using Network PC Cards5-7
PC Card Software5-8
 Configuring PC Cards.....5-8
 Vendor-Provided PC Card Software5-9

Index

Chapter 1

Using This Guide

Thank you for buying a Compaq Mobile Internet PC. This Features Guide will help you to familiarize yourself with the features of your Internet PC, as well as give you information on how to upgrade your computer.

Please take a moment to familiarize yourself with the special text and messages used throughout this guide.

Text Conventions

The examples below explain the specially formatted text used in this guide.

- Keyboard key names appear in bold type: **Home, End, Backspace, Tab**
 - Keyboard keys that must be pressed at the same time to perform a task appear in bold type with a plus (+) between the key names: **Ctrl+Home**
 - Drives appear as capital letters: drive C
 - Folder names appear with initial capital letters: Favorites
 - File names appear in italics with an initial capital letter: *Setup.exe*
 - Command line statements appear in lower case bold type: **a:\install**
 - Names of icons appear in bold type followed by a picture of the icon: **My Computer**  icon
 - Menu items appear in bold type: **Programs, Accessories**
-

Special Messages

The following words and symbols have special meaning in this guide.



HINT: Helpful hints that will make using your computer easier and faster.



NOTE: Important information concerning the operation of your Internet PC.



CAUTION: Failure to follow directions may result in equipment damage or loss of data.



WARNING: Failure to follow directions may result in bodily harm or loss of life.

Locating Help

Compaq provides you with several resources to help you learn about your Internet PC. These resources include the following:

Glossary

Computer terms that may be unfamiliar to you are identified in the glossary.

Index

The index is a comprehensive list of the topics covered in this guide.

Troubleshooting

The Troubleshooting section shows how to fix many common computer-related issues.

Understanding Your Service and Support Options

Your Internet PC is equipped with several helpful programs that will aid you in identifying and solving common computer problems.

If you need further technical support, visit the Compaq Web site at:

www.compaq.com/athome/support

Compaq Technical Support telephone numbers are listed in the Limited Warranty Statement.



NOTE: Locate the model and serial numbers for your computer before you call technical support. Write these numbers down for future use.

Comments about this Guide

Compaq Computer Corporation welcomes comments and suggestions you may have concerning this guide. Send correspondence to the following address:

COMPAQ COMPUTER CORP
ATTN: DOCUMENTATION PROGRAM MANAGER
MAIL CODE 060504
20555 SH 249
HOUSTON TX 77070



NOTE: This address is for comments and suggestions only. It is not for the purpose of obtaining technical assistance.



Chapter 2

Introducing Your Mobile Internet PC

Checking Your Connections

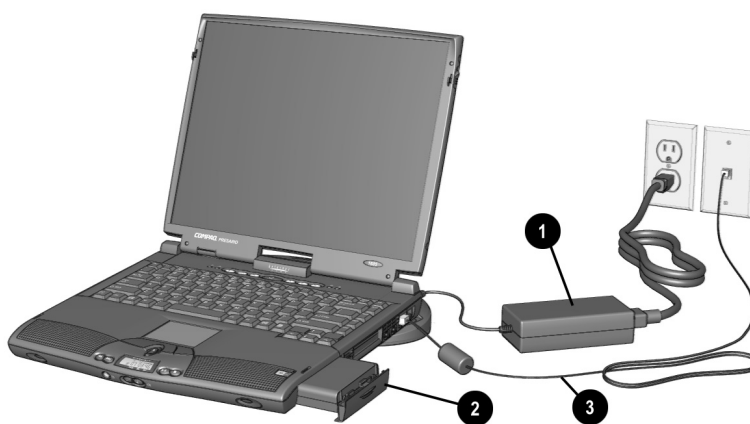

Your Computer Connections

Connections	
❶ AC Adapter	❸ Modem Cable
❷ Battery	

Front of Your Mobile Internet PC

The following buttons, lights, and controls are located on the front of your computer:

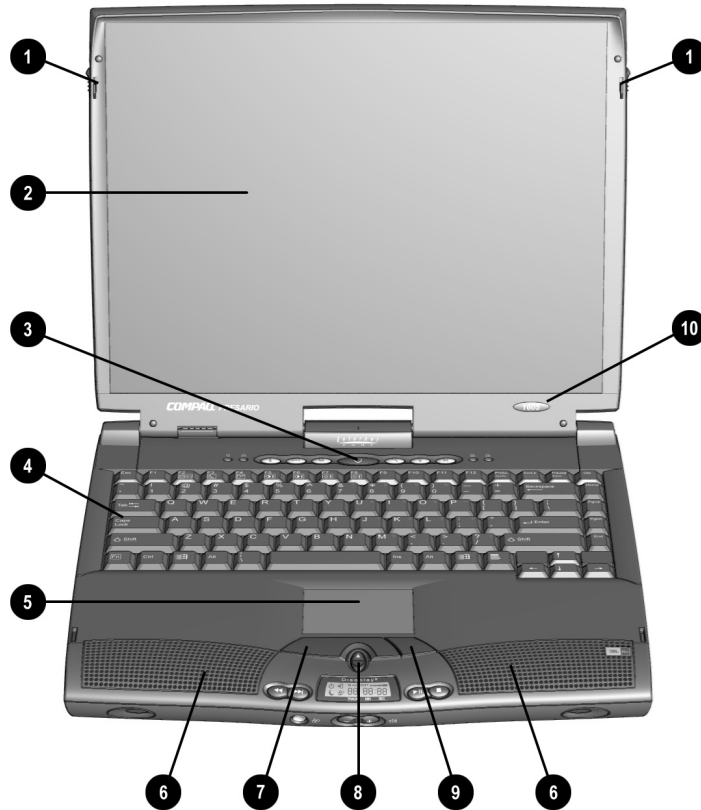

Front of Your Computer

Front Components	
❶ Display Release Latch	❹ Speakers
❷ Display	❺ Left TouchPad Button
❸ Power Button	❻ Scroll Up/Down Button
❹ Keyboard	❼ Right TouchPad Button
❺ TouchPad	❽ Model Number

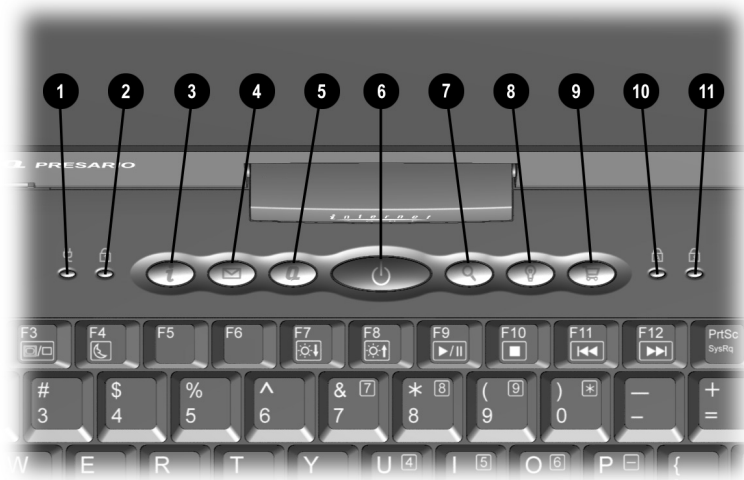

Internet Zone Buttons and Lights

Internet Zone Buttons and Lights	
❶ AC Adapter Light	❷ Instant Search Button
❸ Caps Lock Light	❸ Instant Answer Button
❹ Instant Internet Access Button	❹ Instant E-Commerce Button
❺ Instant E-Mail Button	❺ Num Lock Light
❻ My Presario Instant Access Button	❻ Scroll Lock Light
❼ Power Button	

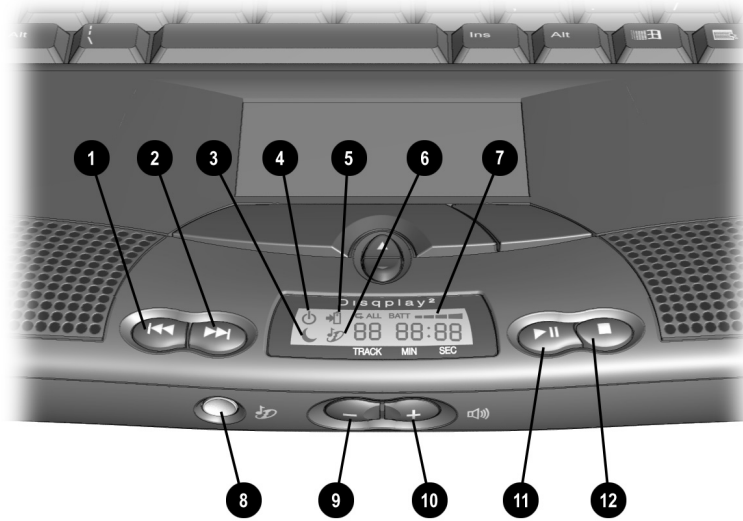

Front of Your Computer

Front Components	
❶ Previous Track Button	❷ Battery Gauge
❸ Next Track Button	❸ Disqplay ² On/Off Button
❹ Sleep Status Icon	❹ Volume Down Button
❺ Power Status Icon	❺ Volume Up Button
❻ Battery Charging Status Icon	❻ Play/Pause Button
❼ Disqplay ² Status Icon	❼ Stop Button







Refer to the Understanding the Status Display section in this guide for more details about the icons found on the display.

Using Your Keyboard to Access the Internet

The Compaq Internet Zone buttons provide quick, easy access to the Internet.

Internet Zone Buttons

The Internet Zone buttons, located at the top of the keyboard of your Mobile Internet PC, automatically connect you to the Internet. Before using these buttons, you must have access to the Internet. These buttons give you quick access to the most frequently used Internet activities. These buttons are programmed to do the following:

Internet Zone Buttons	
Button	Description
	Instant Internet Access connects you to a personalized Web page filled with local weather, news, sports, and financial information.
	Instant E-mail opens the Microsoft Outlook Express e-mail program. For AOL subscribers, this button opens your AOL e-mail account.
	My Presario is your direct link to the Compaq Help Web site for quick answers to your computing questions.
	Instant Search opens a search engine Web site that helps you locate information on the Internet.
	Instant Answer connects you to a Web page that is a central location for solving problems and answering questions.
	Instant E-Commerce takes you to an electronic shopping experience. Compaq has worked with several companies to provide you with the convenience of catalog shopping at the touch of a button. In some regions, the Featured Website button replaces the Instant E-Commerce button.

Reprogramming Your Internet Zone Buttons



You can reprogram the Internet Zone buttons to reflect your personal preferences.

The **Easy Access Internet Zone**  icon is located on the Windows Taskbar. It can also be reached by clicking the **Start** button, then **Programs** and choosing **Reprogram Easy Access Buttons**.

To reprogram your Internet Zone buttons, complete the following steps:

1. From the Status bar, right-click the **Easy Access Internet Zone**  icon and choose **Reprogram Easy Access Buttons**.
2. From the Compaq Easy Access Button Settings window, click the button you wish to change.
3. Follow the instructions provided.

Disabling and Enabling the Internet Zone Buttons

You may turn off all Internet Zone buttons from the Easy Access Button program. When turned off, no Internet Zone buttons will operate. The **Easy Access Internet Zone**  icon located on the Taskbar will appear with a red X on top. You can still access the button functions if you click the **Easy Access Internet Zone**  icon.

To disable the Internet Zone buttons, complete the following steps:

1. From the Windows Taskbar, right-click the **Easy Access Internet Zone**  icon.
2. Click **Disable Easy Access Buttons**.

To enable the Internet Zone buttons, complete the following steps:

1. From the Windows Taskbar, right-click the **Easy Access Internet Zone**  icon.
 2. Click **Enable Easy Access Buttons**.
-

Left Panel of Your Mobile Internet PC

The following components are located on the left panel of your computer:

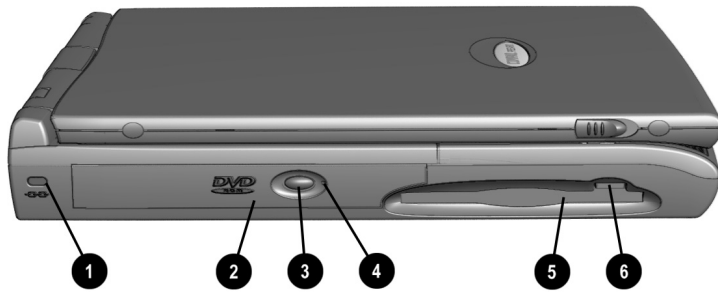

Left Panel of Your Computer

Left Panel Components	
❶ Security Slot	❷ CD or DVD Manual Eject Hole
❸ CD or DVD Drive	❹ Diskette Drive
❺ CD or DVD Eject Button	❻ Diskette Eject Button

Right Panel of Your Mobile Internet PC

The following components are located on the right panel of your computer:



Right Panel of Your Computer

Right Panel Components	
❶ Battery Compartment	❷ Headphone Jack
❸ PC Card Eject Button	❹ Microphone Jack
❺ PC Card Slot	❻ Modem Port

Back Panel of Your Mobile Internet PC

The following components are located on the back panel of your computer:

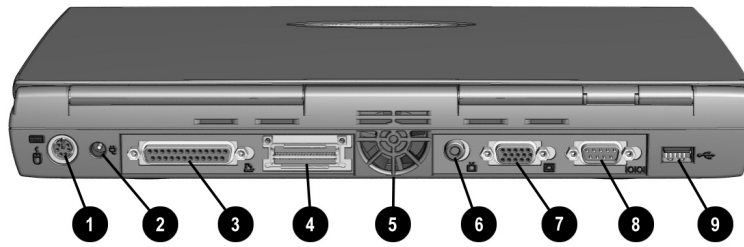

Back Panel of Your Computer

Back Panel Components

❶	Mouse/Keyboard Port	❹	TV Out Connector
❷	AC Adapter Connector	❺	VGA Port
❸	Printer/Parallel Port	❻	Serial Port
❹	Port Replicator Connector	❼	USB Port
❺	Fan Vent		

Bottom of Your Mobile Internet PC

The following components are located on the bottom of your computer:

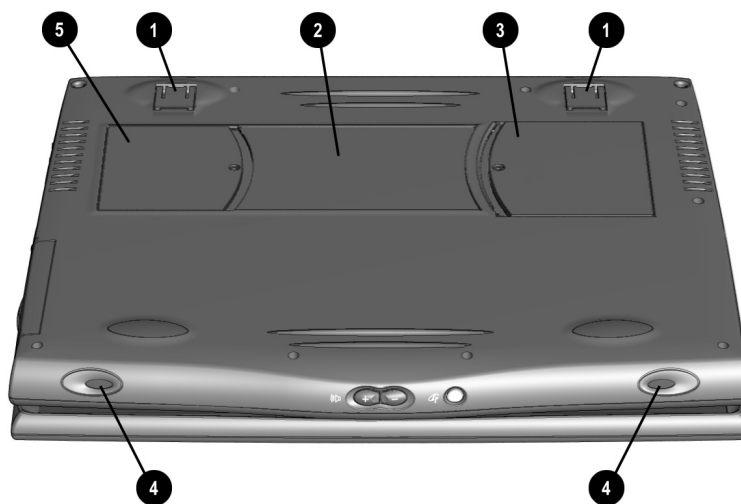

Bottom of Your Computer

Bottom Components	
❶ Pop-Up Feet	❷ Speaker Ports
❸ Serial Number	❹ Modem Door
❺ Memory Compartment	

Inserting the Battery

To insert your battery into the battery compartment, complete the following steps:

1. Push down on the battery compartment door to remove the door.

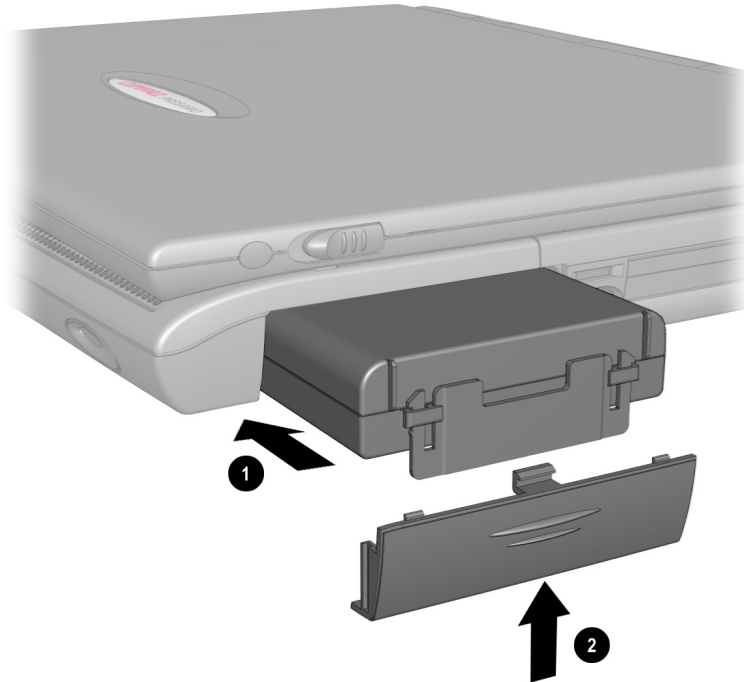

Inserting the Battery

2. Insert the new battery ❶ into the battery compartment with the label side turned up.



NOTE: Only Compaq 1600 Series Mobile Internet PC batteries should be installed in your computer.

3. Close the battery compartment door ❷ by gently pushing up on the door until it snaps into place.
-

Removing the Battery

To remove the battery, complete the following steps:

1. Save your files.
2. If the AC adapter is not connected, turn off your computer.
3. Remove the battery compartment door by sliding it down.
4. Use the tab on the battery to pull the battery out.



WARNING: To reduce the risk of damage to the battery or personal injury, do not crush, puncture, or incinerate the battery or short the metal contacts. Do not attempt to open or service the battery.

Charging the Battery

Charge the battery by connecting your computer to AC power. The battery receives a charge whether your computer is on or off and continues charging until the battery is fully charged or the AC power is disconnected. The **Battery Charging**  icon is displayed when the battery is charging.



NOTE: When you charge the battery the first time, leave your computer plugged into the electrical outlet until the battery pack is fully charged and the **Battery Charging**  icon is no longer displayed. This measure ensures that your battery is completely charged.

Battery Charging Time

Battery charging time will vary based on the initial battery charge, the type of battery, and the activity of your computer while charging.

Spare or Extra Batteries

To purchase extra batteries for your Compaq Internet PC, contact an authorized dealer or the Compaq Web site at:

www.compaq.com/athome

Next, click **onlinestore**→**accessories**→**notebook options**→**accessories** or call 1-800-888-0220.

Plugging In Your Computer to AC Power

To connect your computer to AC power, follow the instructions on the *Compaq Hardware and Software Setup* poster. Refer to the Government Approvals section of the Mobile Internet PC Reference Manual for worldwide power cord information.

Unplugging the Computer from AC Power

When your computer does not have a charged battery, you should save your work and turn off the computer before unplugging it from AC power.

When a charged battery is in the computer, you can simply unplug it from AC power. The computer automatically switches to battery power.

WARNING: Make sure you can easily reach the electrical outlet. Unplug the AC adapter from the electrical outlet when you want to disconnect power from your computer. Do not leave the AC adapter plugged into the electrical outlet.



WARNING: Do not place anything on power cords or cables. Arrange them so that no one will accidentally step on or trip over them. Do not pull on a cord or cable. When unplugging from the electrical outlet, grasp the cord by the plug.

WARNING: To reduce the risk of electrical shock, fire, or damage to the equipment, do not use converter kits sold for appliances to power your computer.



Chapter 3

Mobile Internet PC Features

Turning On Your Mobile Internet PC

To turn on your computer, press the **Power**  button, which is located at the top of the keyboard.

Turning Off Your Mobile Internet PC Properly

Standard Off Mode

To turn off your computer properly, complete the following steps:

1. Save any work you want to keep by clicking the **File** menu, then clicking **Save**. If the Save As window is displayed, type in a file name and specify where you want to save the file, then click the **Save** button.
2. Exit the program you are using by clicking the **Close** button in the top right-hand corner of the window.
3. Maximize and close any windows shown on the Taskbar at the bottom of the screen.
4. Repeat steps 1, 2, and 3 for each window you have open until only the Windows desktop remains active.
5. Click the **Start** button, then click **Shut Down**.
6. Select the **Shut down** option.
7. Click the **OK** button. After a few seconds, your computer will turn off.



NOTE: Your computer cannot receive faxes when it is turned off or in Hibernation mode.

Full Off (Main Power Off) Mode

If you need to install or replace components in your computer, you must turn your computer off *completely*. To do this, complete the previous steps for putting your computer into Standard Off mode. Unplug the computer electrical cord from the outlet and remove the battery if installed.

Recovering from a Locked Program or System

Recovering from a Locked Program

To recover from a frozen software program, complete the following steps:



1. Press **Ctrl+Alt+Delete**. The Close Program window displays.
2. Select the program that is not responding.
3. Click the **End Task** button. A message displays prompting you to close the program that is not responding.
4. Click **End Task**.



NOTE: Learn to save your work often. Work that has not been saved may be lost when a program or the computer stops responding.

Recovering from a Locked System

Occasionally you may encounter a nonworking keyboard or a frozen screen. To restart your computer, complete the following steps:

1. Press and hold down the **Power**  button for at least four seconds. This action will cause a manual shutdown.
2. Press the **Power**  button once to restart.

If your computer still does not restart, complete the following steps:

1. Remove the battery and unplug the AC power for at least 30 seconds.
2. Reinsert the battery or reconnect AC power and press the **Power**  button once to restart.

If files were open when the computer locked up, ScanDisk, a Microsoft Windows utility program, will automatically run. ScanDisk will determine if the improper shutdown caused any errors on the hard drive. Errors may occur if the Microsoft Windows operating system was not able to properly close all files before the shutdown. If no errors are found, the restart process will continue. If ScanDisk does detect errors, follow the instructions shown to continue the restart process. Work that was not saved prior to the lockup may be lost.

Using the Numeric Keypad

To use the embedded numeric keypad, press **Fn+NumLk**. This key combination switches the keys to numbers until you press **Fn+NumLk** again. When NumLock is activated, the **NumLock**  light is turned on.



NOTE: If an external keyboard or numeric keypad is connected, pressing **Fn+NumLk** on the notebook keyboard will not activate NumLock. You must press the **NumLock** key on the external keyboard or numeric keypad to activate NumLock.



Numeric Keypad

Using the Scroll Button





If you are using a program that has a vertical scroll bar, the scroll button beneath your touchpad will allow you to scroll up and down a page.

To change the function of the scroll button, complete the following steps:

1. Click the **Start** button from the Windows Taskbar.
2. Point to **Settings**, then click Control Panel.
3. Double-click the **Mouse**  icon.
4. Click the **Button Actions** tab. Change the selection in the **Rocker Switch** column of the **Buttons** panel.









Understanding Your Computer Status Lights

Status lights show what is happening in your computer.

Icon	Lights up when...
	AC Adapter – AC adapter is plugged in.
	Caps Lock – This feature is activated. When used, letters are typed in uppercase. To turn Cap Lock on, press the Caps Lock key.
	Num Lock – This feature is activated. You can use the embedded keypad to enter numbers. To turn on Num Lock mode, press Fn+NumLock .
	Scroll Lock – This feature is activated. Text that takes up more than a full screen scrolls up the screen line-by-line. To turn on Scroll Lock, press the ScrLock key.

Understanding Your Status Display

The icons on your computer status display show what is happening in your computer. If you press any of the buttons around the status display (except the Volume Up or Volume Down buttons), it will light up for a few seconds so that you can see the icons more clearly.

Icon Functions		
Function	Icon	Displays when...
Power		Main power is on. Display ² will not play when your computer is turned on.
Battery Charging		Your battery is charging.
Repeat		The current track that is playing will be repeated once it ends. (Display ² only)
Repeat All		The current CD that is playing will be repeated once it ends. (Display ² only)
Battery Gauge		The battery is inserted. The amount of power remaining in the battery is displayed in 25 percent increments. The battery gauge will start blinking when your battery has less than 10 percent of power remaining.
Sleep		The computer is in Sleep mode. Display ² will not play when your computer is in Sleep mode.
Display ²		Display ² is turned on.
Track/Time		A CD is inserted. The first two digits indicate the track number, the next four digits indicate the time left playing in the track. If the Track/Time display is blinking, the CD is paused. (Display ² only)

Using the Function Keys

Use the function keys on the keyboard to perform repeated tasks quickly. The function keys are located on the top row of the keyboard. The **Fn** key activates a function key. It is located in the lower-left area of the keyboard.

To use a function key, press the **Fn** key at the same time you press a function key.



Function Keys and Fn Key















User-Programmable Keys

The **F1** and **F2** keys can also be set up to open your most often-used software, thereby saving you time from having to locate these programs every time you want to use them.

Refer to the Reprogramming Your Internet Zone Buttons and Function Keys section in this guide for more information about programming the **F1** and **F2** keys.

The following keys have already been assigned:

Function Keys		
Function Keys	Icon	Description
F1		User-programmable favorite program launch key
F2		User-programmable favorite program launch key
F3		Switches between the display and external monitor in the following order: <ul style="list-style-type: none"> • External Monitor • Display and External Monitor • TV Out • Display
F4		Sleep
F5		Contrast Down*
F6		Contrast Up*
F7		Brightness control down
F8		Brightness control up
F9		CD or DVD play/pause
F10		CD or DVD stop
F11		CD or DVD previous track
F12		CD or DVD next track

* Available only on select models

Adjusting the Volume

You can change the speaker volume on your Internet PC. Press the **+** button to increase the volume. Press the **-** button to decrease the volume. Pressing the **-** and **+** buttons at the same time will turn on and turn off the mute feature.



WARNING: To reduce the risk of personal injury or equipment damage, reduce the speaker volume before putting on headphones.

Adjusting the Volume Using Windows

To adjust the volume using Windows, single-click the **Volume**  icon on the Windows Taskbar. Use the slider bar to adjust the volume. Click the **Mute All** box to mute the volume.

Using Disqplay²

Your Compaq Internet PC features Disqplay² technology. Disqplay² allows you to play CDs on your Internet PC while main power is turned off, a convenient way to play CDs while greatly reducing the amount of power used by your computer.







With Disqplay² you can:

- Insert an audio CD and it will automatically start playing.
- View the total playing time and number of tracks on an audio CD when it is stopped.
- View the track number and time remaining within the track.
- Fast forward or rewind within a CD track.
- Continuously repeat a track or repeat an entire disc once it has reached the end of the last track.
- Press a button (except for Volume Up or Volume Down) and your status display will light up for a few seconds so you can see the icons more clearly.

Disqplay² will also turn itself off if your CD has stopped playing and no activity has occurred for a certain amount of time.

3-10 Mobile Internet PC Features

For a list of the buttons used to operate Display², please see the table below.

Button Functions		
Function	Icon	Description
Display ² On/Off		Turns Display ² on and off. You must hold down the button for 1 second to turn on or turn off Display ² .
Previous Track		Skips the CD to the previous track. If you hold the button down for 1 second, it will rewind through the song. When the CD is paused, pressing this button will start Repeat Track mode.
Next Track		Skips the CD to the next track. If you hold the button down for 1 second, it will fast forward through the song that is playing. When the CD is paused, pressing this button will start Repeat All mode.
Play/ Pause		Starts or ends Play or Pause mode. In combination with other buttons, this button will start Repeat Track or Repeat All mode.
Stop		Stops the CD playing.
Volume Down*		Turns down the volume of the CD.
Volume Up*		Turns up the volume of the CD.

* Pressing the Volume Down and Volume Up buttons at the same time will turn on and turn off the mute feature.

Playing Audio CDs Using Display²

To play an audio CD using Display², press the **Display² On/Off** button for 1 second to turn on Display², then insert the CD into the CD drive. The CD will automatically start playing. Use the CD control buttons to navigate the CD.

If there is no CD in the CD drive, a **No Disc** message will appear on the status display.



No Disc Message

3-12 Mobile Internet PC Features

If there is a data (non-audio) CD in the CD drive, a **Data CD** message will appear on the status display. Display² will not run data CDs.



Data CD Message

Using Repeat Track

To continuously repeat a track, complete the following steps:

1. While the track is playing, press the **Play/Pause** ►|| button.
2. Press the **Previous Track** ◀◀ button. The **Repeat** ↶ icon will appear on the status display and the track will start playing.
3. Press any button to stop the track from repeating.

Using Repeat All

To continuously repeat a CD, complete the following steps:

1. While the track is playing, press the **Play/Pause** ►|| button.
 2. Press the **Next Track** ►► button. The **Repeat All** ↶ ALL icon will appear on the status display and the track will start playing.
 3. Press any button to stop the CD from repeating.
-

Setting Up Your TV-Out Connection

Your Mobile Internet PC comes with a composite TV-Out connector on the back panel. An S-Video connector can be found on your optional port replicator.

With a TV-Out connection, you can do the following:

- Play games on a bigger screen, such as your television.
- Watch DVD movies on TV rather than a computer monitor.
- Play a video clip for recording on a VCR.

Connecting and Enabling TV-Out

To connect your computer and your television, you will need a composite video cable (RCA cable) to plug into your TV, VCR, or other device. These cables can be purchased in a retail TV store or a computer store.

To connect and enable TV-Out, complete the following steps:

1. Connect your TV to your computer.
 2. Turn on the TV, then turn on your computer or if your computer is already on, restart it.
 3. Right-click the Windows desktop.
 4. Click **Properties**.
 5. Click the **Settings** tab, then click the **Advanced** button.
 6. Click the **Display Devices** tab.
 7. Click the **TV** Radio button under Display Devices and click the **Apply** button to select the TV output.
 8. Click the **OK** button to activate the warning message that verifies that the TV is turned on and is plugged into the computer.
-

3-14 Mobile Internet PC Features

9. Click the **OK** button to confirm the change or after 15 seconds, the original settings will be restored.
10. Click the **OK** button to exit the Advanced menu and the Display Properties menu.



NOTE: The TV will default to the Overscan mode (panning mode). To select the Underscan mode (non-panning), Check the **Enable Underscan** Box under the TV tab in the **Advanced settings of the Display Driver menu**. (Refer to steps 3-5 above.)



Setting Up Your Television Format

To properly view images, you must set your computer to your country's standard for television transmission. To do this, complete the following steps:

1. Right-click the Windows desktop.
2. Click **Properties**.
3. Click the **Settings** tab, then click the **Advanced** button.
4. Click the **Display Device** tab.
5. Click the **TV Standard** dropdown box.
6. Scroll to find your TV format, then select it.
7. Click the **OK** button to exit the Advanced menu and the Display Properties menu.

Your television format is now set.

Adjusting the Television Screen

After you have enabled your television, you may need to adjust the size or location of your screen.

To make adjustments to your screen, complete the following steps:

1. Right-click the Windows desktop.
 2. Click **Properties**.
 3. Click the **Settings** tab, then click the **Advanced** button.
 4. Click the **Television** tab.
 - a. To change Tint, Saturation of the screen or Brightness, use the sliders under **Color Adjustment**.
 - b. To change the position, click the arrow buttons next to Position.
 5. Click the **OK** button to exit out of the Advanced menu and the Display Properties menu.
-

Switching Between Displays

You can switch between your television and your display or external monitor by pressing **Fn+F3**. The order in which they change is:

- External Monitor
- Display and External Monitor
- TV-Out
- Display

Write-Protecting a Diskette

The write-protect tab on a standard 3.5-inch diskette serves the purpose of not allowing you to save data to or delete data from the diskette.

The write-protect tab functions the same way as on a standard 3.5-inch diskette. If the hole is covered, you can read and write to the diskette. If the hole is open, you can only read from the diskette.

Chapter 4

Learning About Your Modem

Your Internet PC is equipped with a 56K V.90 data/fax modem. Before using your modem to connect to the Internet, you must establish an account with an Internet service provider (ISP).

Performance Features

Your modem has several features that significantly enhance its performance. These features include the following:

- 56K ITU V.90 compliant – Your modem is ready to operate using the International Telecommunications Union V.90 standard.
- K56flex compliant – If your ISP uses the K56flex protocol, the modem will automatically use this protocol to establish a connection.
- Data/fax capable (refer to the Sending and Receiving Faxes section).

Identifying Your Modem

To learn more about the modem installed on your computer, complete the following steps:

1. From the Windows Taskbar, click the **Start** button, point to **Settings**, and then click **Control Panel**.
2. Double-click the **Modems**  icon.

In the Modem Properties window, the names of the installed modems are displayed.

56K ITU V.90 Standard

If you are able to connect to an ISP using the V.90 standard, the modem will be able to download files at a maximum speed of 56 kilobits per second (Kbps), over standard telephone lines. Download speeds will vary with telephone line conditions.

When using the V.90 standard, download speeds are faster than upload speeds. The maximum download speed is 56 Kbps and the maximum upload speed is 33.6 Kbps. Transmission rates will vary depending on telephone line conditions.

The V.90 and K56flex protocols are designed only to increase the download transmission rate from V.90 or K56flex compliant digital sources. Maximum achievable download transmission rates are currently unknown, may not reach 56 Kbps, and will vary with telephone line conditions.

Chapter 5

Upgrading Your Mobile Internet PC

Adding More Memory

Memory upgrades of 32, 64, or 128 megabytes (MB) of random access memory (RAM) are available for your computer. Contact your Compaq retailer, seller, or authorized dealer for information on memory or refer to your accessories catalog.

The memory specifications for your Mobile Internet PC are as follows:

- 144-pin SODIMMs (small outline dual inline memory modules)
- SyncDRAM (synchronous dynamic random access memory)
- 3.3 volt

Select PC100 compatible memory if your system is equipped with a Celeron™ processor. Select PC133 compatible memory if your system is equipped with a Pentium III™ processor.



CAUTION: Electrostatic discharge can damage electronic components. Before beginning this procedure, make sure you are properly grounded (discharged of static electricity) by briefly touching a grounded, unpainted metal object or surface.



Installing Memory Expansion Modules



CAUTION: It is recommended that you use Compaq memory modules when expanding memory. The use of non-Compaq memory modules may cause potential warranty issues.

To properly install memory modules, complete the following steps:

1. Turn off your computer using the Windows shutdown process.



CAUTION: If you enter Hibernation mode instead of turning off your computer when adding memory, you will lose data.

2. Disconnect all power sources and external hardware from your computer.
3. Remove the battery from its compartment.
4. Turn your computer over and locate the memory compartment door.
5. Use a Phillips screwdriver to remove the screw from the memory compartment door.
6. Remove the memory compartment door.
7. Slide ❶ and lock ❷ the memory expansion module in place.



CAUTION: When installing memory expansion modules, apply gentle, even pressure when inserting the memory module. Excessive pressure can damage the memory module.



NOTE: Make sure the memory module is properly seated and snapped into place. If it is not seated, you may see memory error messages or your computer may not recognize the memory module.

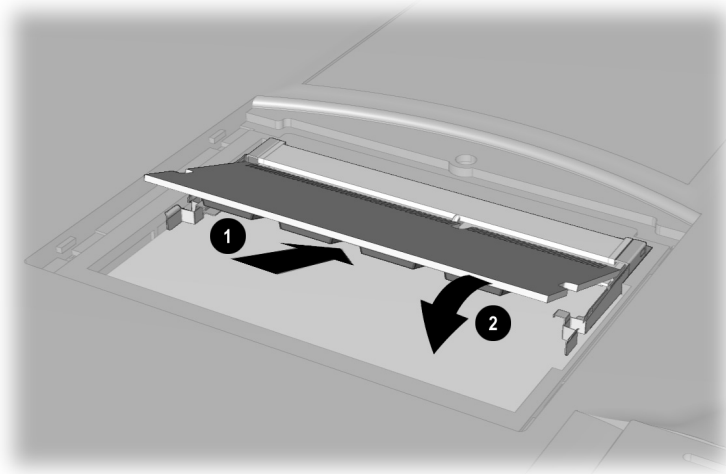

Installing the Memory Expansion Module

8. Replace the memory compartment door.
9. Reinsert the screw.



What Are PC Cards?

PC Cards (formerly known as PCMCIA Cards) are removable devices that increase the storage or communications capability of your computer. PC Cards come in three different sizes: Type I, Type II, and Type III. PC Cards have the following things in common:

- 2 standard bus sizes, 16-bit (PCMCIA) or 32-bit (CardBus)
- 68-pin connectors
- approximately the same size as a credit card, but differences in thickness

PC Cards are easy to install. Other issues, however, especially software considerations, can impact your ability to use them effectively.

The Personal Computer Memory Card International Association (PCMCIA) was formed in 1989 to set industry standards for the use of PC Card technology. PCMCIA represents more than 500 companies in the computer industry. As a member of PCMCIA's Board of Directors and Executive Committee, Compaq is a driving force in the PC Card industry.

PC Card Types

PC Card types vary as follows:

- Type I cards are usually memory cards and are the thinnest at 3.3 mm.
 - Type II cards, such as modem cards, are 5.0 mm thick.
 - Type III cards, typically hard disk drives, are the thickest at 10.5 mm.
 - Extended Type I, Type II, and Type III PC Cards are the same height and width as standard size PC Cards. They have added length or thickness at one end so they can accommodate external connectors or wireless PC Card antennas.
-

Inserting a PC Card

To insert a PC Card into your computer, complete the following steps:

1. Guide the PC Card, label side up, through the lower door of the PC Card slot.
2. Gently push the card into the slot. If the computer is turned on, the computer automatically configures the PC Card and beeps when the card is ready to use.



NOTE: Your 1600 Series notebook will only accept one PC Card of any type at one time.



CAUTION: Do not force the card into the slot, as this may damage the connector pins.

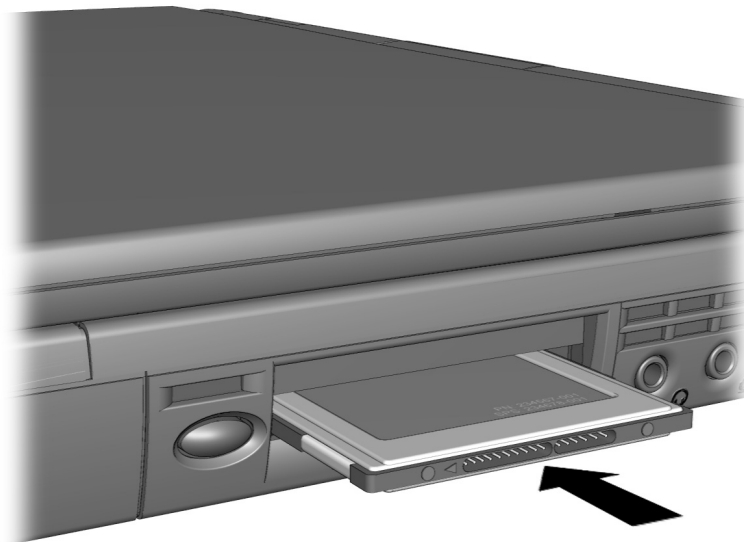

Inserting a PC Card



Removing a PC Card

If your computer is turned on, click on the **PC Card**  icon on the Windows Taskbar to stop card activity before you remove the card. A popup window prompts you to remove the card. Then, follow these steps to remove the PC Card:

1. Push in on the recessed **PC Card Eject** button  to extend it.
2. Push the extended button back into the unit. The PC Card pops out, and if the computer is turned on, the computer will beep.
3. Gently grasp the card and pull it out completely.



Ejecting a PC Card

Compaq-Compatible PC Cards

Internet PCs are compatible with many PC Cards and CardBus PC Cards on the market today. Refer to the documentation that came with your PC Card or contact your PC Card manufacturer for information. The Compaq Web site lists many compatible PC Cards:

www.compaq.com/athome/support/serv_note.html



NOTE: Before buying a non-Compaq PC Card, check the documentation that comes with it to be sure it conforms to standards set by the PCMCIA.

Using Network PC Cards

Your Internet PC can support many types of Ethernet-based and Token Ring-based network cards. This support allows you to connect to other computers, printers, modems, and the Internet.

The *Microsoft Windows 98 Getting Started* guide and the documentation that came with your network card will have more information about setting up to use a network or compatible network card.

Compaq Netelligent PC Card is one of the compatible network PC Cards you can use with your computer. The Compaq Web site lists many compatible network cards:

www.compaq.com/athome/support/serv_note.html

If your computer came with an integrated Ethernet controller, you will not need a PC Card to connect to a network.

PC Card Software

Some types of PC Cards require card-specific device drivers. Contact your PC Card manufacturer for additional information.

Configuring PC Cards

The PC Card software needed to easily install and configure PC Cards in Windows is provided on your Internet PC.

You do not need to turn off your computer or initiate Sleep mode before inserting a PC Card.

When you insert a PC Card for the first time, Windows identifies the new hardware and automatically determines the correct settings for the card to install the needed PC Card drivers. You may be prompted to make simple setup choices. Once you have completed setup for a PC Card, each time you insert that card, Windows remembers the correct settings and configures it automatically.

Depending on the card and the version of PC Card software you are using, you may have to turn on PC Card drivers or install device drivers. Your computer features easy-to-follow popup windows to guide you through the process.

Vendor-Provided PC Card Software

PC Card vendors provide the following types of PC Card software:

Card-specific device driver – If needed, install a card-specific device driver in Windows. It is important to be certain you are installing only a card-specific device driver. Installing the wrong software can limit the card's ability to work properly. If diskettes are not clearly labeled or the instructions are unclear, call your PC Card vendor for more specific information.

Direct or point enabler – An enabler is proprietary software, which means it is designed to support only the card it comes with. An enabler can prevent your computer from working with other PC Cards. When an enabler is used, you lose the benefits of your existing PC Card software. You lose features such as Power Management, Sleep, Hibernation, support for other PC Cards, and the ability to hot plug (to insert cards without restarting your computer).

Enabler software should only be installed by an experienced user. In fact, an enabler is rarely needed.



NOTE: An enabler can disable your computer's ability to function with another PC Card. As a precaution, copy your important files to a diskette before installing an enabler.

NOTE: All Compaq computers with PC Card slots already have PC Card software loaded. Do not install vendor-provided Card and Socket Services.



Index

A

- AC adapter 2-1
- AC power
 - connecting 2-13
 - unplugging 2-13

B

- battery 2-1
 - charging 2-12
 - charging time 2-12
 - compartment 2-8
 - extra batteries 2-12
 - guage 2-4
- buttons
 - CD/DVD eject 2-7
 - diskette eject 2-7
 - Display on/off 2-4, 3-10
 - Instant Answer 2-3
 - Instant E-Commerce 2-3
 - Instant E-Mail 2-3
 - Instant Internet Access 2-3
 - Instant Search 2-3
 - Internet zone 2-5
 - left touchpad 2-2
 - mute 3-10
 - My Presario 2-3
 - next track 2-4, 3-10
 - num lock 2-3
 - PC card eject 2-8
 - play/pause 2-4, 3-10
 - power 2-2, 2-3
 - previous track 2-4, 3-10
 - right touchpad 2-2
 - scroll button 3-5
 - scroll lock 2-3
 - scroll up/down 2-2

- stop 2-4, 3-10
- volume down 2-4, 3-9, 3-10
- volume up 2-4, 3-9, 3-10

C

- CD/DVD
 - drive 2-7
 - manual eject hole 2-7
- computer
 - adjusting volume 3-9
 - back panel 2-9
 - bottom 2-10
 - connections 2-1
 - front 2-2
 - full off 3-2
 - left panel 2-7
 - main power off 3-2
 - right panel 2-8
 - scroll button 3-5
 - standard off 3-1
 - turning off 3-1
 - turning on 3-1
 - TV out 3-13
- connection speeds 4-2
- connectors
 - AC adapter 2-9
 - port replicator 2-9
 - TV out 2-9

D

- diskette
 - drive 2-7
 - eject button 2-7
 - write protecting 3-16
- display 2-2
- display release latch 2-2
- Display
 - buttons 3-10
 - data CDs 3-12
 - next track button 3-10
 - no disc message 3-11
 - on/off button 3-10
 - play/pause button 3-10

Index-2

- playing CDs 3-11
- previous track button 3-10
- repeat all 3-12
- repeat track 3-12
- stop button 3-10
- turning off 3-9
- using 3-9
- download speeds 4-2
- drives
 - CD/DVD 2-7
 - diskette 2-7

F

- fan vent 2-9
- feet
 - pop-up 2-10
- function keys
 - using 3-7

H

- help 1-2
- hibernation 3-1

I

- icons
 - battery charging 3-6
 - battery charging status 2-4
 - battery gauge 3-6
 - Display 2-4, 3-6
 - PC card 0-6
 - power 3-6
 - power status 2-4
 - repeat 3-6
 - repeat all 3-6
 - sleep 3-6
 - sleep status 2-4
 - status display 3-6
 - track/time 3-6
- inserting the battery 2-11
- Instant Answer 2-5
- Instant E-Commerce 2-5
- Instant E-mail 2-5

- Instant Internet Access 2-5
- Instant Search 2-5
- International Telecommunications Union 4-1
- Internet PC 2-2
- Internet zone 2-5
- ITU *See* International Telecommunications Union

J

- jack
 - headphone 2-8
 - microphone 2-8

K

- K56flex 4-1
- keyboard 2-2
 - numeric keypad 3-4

L

- lights
 - AC adapter 2-3
 - caps lock 2-3
 - status 3-5

M

- memory
 - adding 0-1
 - compartment 2-10
 - illustration 0-3
 - installing 0-3
 - specifications 0-1
- Mobile Internet PC 2-2
- model number 2-2
- modem 4-1
 - 56K 4-1
 - cable 2-1
 - data/fax 4-1
 - identifying 4-1
 - properties 4-1
- My Presario 2-5

N

numeric keypad 3-4

P

PC cards 0-4

- CardBus 0-4
- card-specific device driver 0-9
- Compaq Netelligent PC Card 0-7
- compatible 0-7
- compatible network cards 0-7
- configuring 0-8
- definition 0-4
- eject button 2-8
- enablers 0-9
- inserting 0-5
- network cards 0-7
- removing 0-6
- slot 2-8
- software 0-8, 0-9
- type I 0-4
- type II 0-4
- type III 0-4
- types 0-4

PCMCIA *See* PC Cards

ports

- modem 2-8
- mouse/keyboard 2-9
- printer/parallel 2-9
- serial 2-9
- speaker 2-10
- USB 2-9
- VGA 2-9

power

- button 2-2
- full off 3-2
- main power off 3-2
- turning off 3-1
- turning on 3-1

R

restarting the computer 3-3

S

- Scandisk 3-3
- securing your computer
 - security slot 2-7
- serial number 2-10
- serial numbers 1-3
- slots
 - PC card 2-8
 - security 2-7
- speakers 2-2
- status display 3-6
- status lights 3-5

T

- text conventions 1-1
- touchpad 2-2
 - left button 2-2
 - right button 2-2
- turning on and off your computer 3-1
- TV out 3-13
 - adjusting television screen 3-15
 - connecting 3-13
 - displays 3-16
 - enabling 3-13
 - format 3-15

U

upload speed 4-2

V

- V.90 standard 4-1, 4-2
- volume
 - adjusting 3-9
 - control 3-9

W

write protecting 3-16

The information in this guide is subject to change without notice.

COMPAQ COMPUTER CORPORATION SHALL NOT BE LIABLE FOR TECHNICAL OR EDITORIAL ERRORS OR OMISSIONS CONTAINED HEREIN; NOR FOR INCIDENTAL OR CONSEQUENTIAL DAMAGES RESULTING FROM THE FURNISHING, PERFORMANCE, OR USE OF THIS MATERIAL.

This guide contains information protected by copyright. No part of this guide may be photocopied or reproduced in any form without prior written consent from Compaq Computer Corporation.

© 1999 Compaq Computer Corporation. All rights reserved. Printed in the U.S.A., Brazil, Canada, Japan, Korea, Singapore, Taiwan, and the U.K. Compaq and Presario are registered in the U.S. Patent and Trademark Office.

Microsoft, MS-DOS, and Windows are registered trademarks of Microsoft Corporation.

The software described in this guide is furnished under a license agreement or nondisclosure agreement. The software may be used or copied only in accordance with the terms of the agreement.

Product names mentioned herein may be trademarks and/or registered trademarks of their respective companies.



158562-001